



X-ray Inspection System

IX-G2 Series



Dual Energy Sensor absorptiometry detects what other inspection system miss.

**Most effective X-ray detection of low-density objects,
including thin pieces of metal, glass, shell, bone, and rubber**



- ┃ Reduces false rejects and product giveaway
- ┃ Integrated air cooling system, user-friendly 17" touch screen control
- ┃ Provides easy access for sanitation with stainless steel construction



Energy Analysis for Highly Sensitive Detection

Compares two images with different properties and detects foreign objects based on differences in physical properties. Clearly detects overlapping product and foreign objects that are difficult to recognize, such as bone.

Dual Energy Sensors

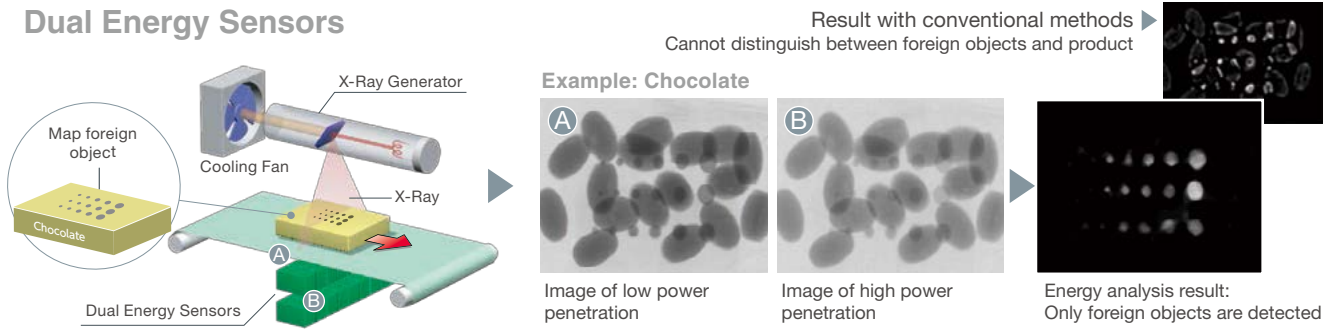

Product and Foreign Object Separated According to Physical Property

1 H Hydrogen	2 He Helium	3 Li Lithium	4 Be Beryllium	5 B Boron	6 C Carbon	7 N Nitrogen	8 O Oxygen	9 F Fluorine	10 Ne Neon	11 Na Sodium	12 Mg Magnesium	13 Al Aluminum	14 Si Silicon	15 Ca Calcium
--------------------	-------------------	--------------------	----------------------	-----------------	------------------	--------------------	------------------	--------------------	------------------	--------------------	-----------------------	----------------------	---------------------	---------------------

Elements that are often included in food products (Hydrogen-oxygen)

Elements that are easy to detect as foreign objects (Stones & glass = silicon, bone = calcium, etc.)

GA Evolutionary Image Processing

*GA Evolutionary Image Processing is a registered trademark of National University Corporation, Yokohama National University.

Employs the latest image processing technology of GA Evolutionary Image Processing. The computer automatically creates the optimum image processing program for differentiating between foreign objects and food products. GA is easy to create. Using programs optimized for each inspection object, anyone can inspect with high sensitivity.

Example: Detecting foreign objects in frozen pilaf

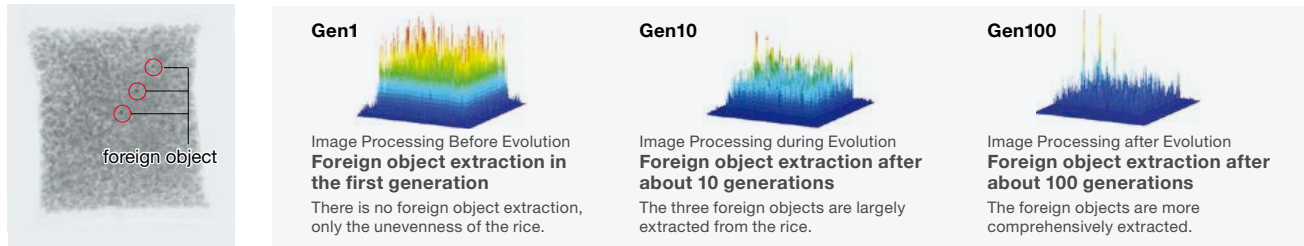

Detects with High Sensitivity Foreign Objects That Conventional Machines Cannot Detect and Reduces False Positives

<p>Wieners</p>	<p>Conventional Machine</p> <p>Bone Bone</p> <p>False positive Cannot detect</p>	<p>Dual Energy</p> <p>Bone Bone</p> <p>Bone accurately detected with no false positives</p>
<p>Oysters (inspected items are frozen)</p>	<p>Conventional Machine</p> <p>Cannot detect</p>	<p>Dual Energy</p> <p>Detection sensitivity greatly increased!</p>

Uses Image Processing Technology to Improve Product Quality

Uses high-level image processing technology to simultaneously detect foreign objects and accurately inspect products.

Standard Features



Defect Inspection

Determines whether a product has passed the inspection or not based on factors including the area of an individual product, its perimeter length and its shading.

Masking Feature

The sensitivity of foreign object detection is improved by taking into consideration individual product attributes and masking areas that may cause false positives.

Weight Estimation Feature Comes as Standard

Analyzes x-ray inspection images and accurately estimates the weight of the inspected item. This feature can be useful for example for continuous packaged goods where individual weight inspection is not possible, and for ranking agricultural and marine products.

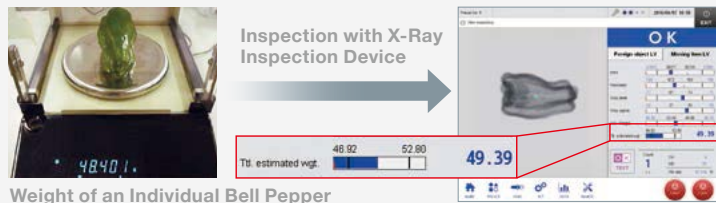

Weight of an Individual Bell Pepper

A Variety of Image Processing Features



Defect Inspection for Loose Products

Inspects for defects such as cracks even for loose products.

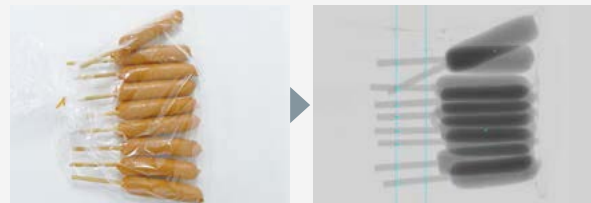

Multiple Cylindrical Object Inspection

Specifies the count area, and counts the number of skewers. Prevents missing and broken skewers.

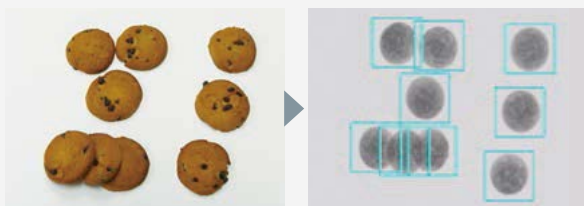

Multiple Flat Object Inspection

Counts the number of pieces of overlapping flat products.



Individual Weight Inspection

Simultaneously measures the weight of each specified area.

Easy to Operate

Configuring Energy Analysis is Easy with Auto Set

It only takes a few passes of an item to be inspected for the device to automatically optimize settings for x-ray output (tube voltage and current), contrast (image enhancement), sensitivity level and other factors. Although energy analysis requires experience, the system automatically configures the analysis so even beginners can easily perform high-sensitivity inspections.



Sensitivity Setting Screen



Auto Set Screen

Simply enter the size of the object to inspect and check the required items!



Large
17-Inch
Display

Featuring multilingual support

It supports 10 languages. This makes it easy to use for operators from various countries.

Easy to Change Products

To change products, simply call up a preset program from the screen. It is a simple three-step operation.

Many types of data management are possible

Data Collection Software **i-STATION LINK 2** Option

This application allows you to check—by using the PC—x-ray images, inspection data and the operating status for machines that are working together.

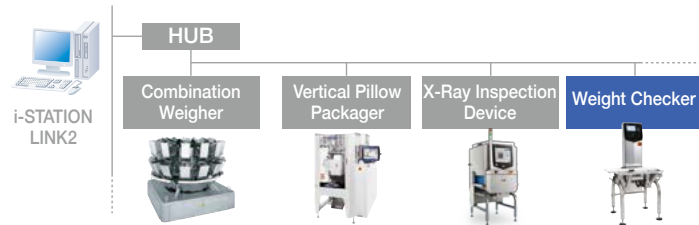
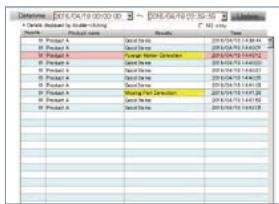

Traceability System Option

This system stores all x-ray images and inspection data, and at the same time prints linked individual ID numbers on the product or on a label to be attached to the product. If a complaint or other issue is brought forward by a market, you can check x-ray images and inspection information made at the time of shipping. This will be helpful in investigating the cause.

Example of Line Configuration

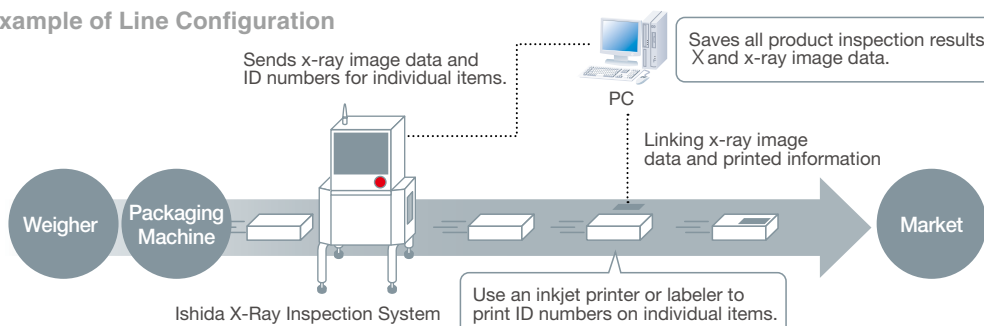

Printing on the product with invisible ink
Check using a black light.



Printed Label

A variation for every purpose

Numerous variations support many types of inspection.

This Type (IX-G2-E) Is Designed especially for Sensing Low-density Foreign Objects (bones, shells, rubber, etc.)

This type has improved detection sensitivity for low-density foreign objects such as bones and shells. Detection sensitivity is significantly better than that of conventional machines equipped with dual energy sensors.

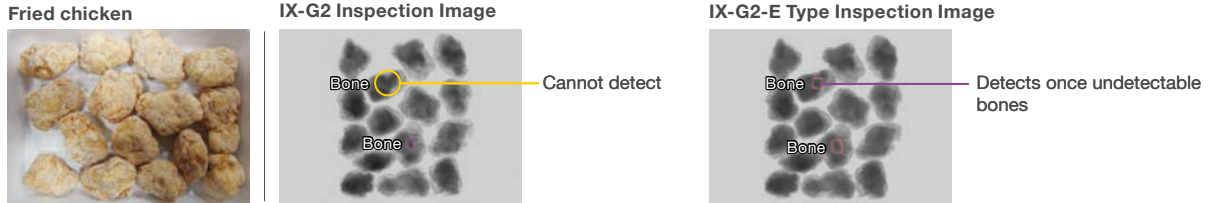

Power Save Conserves Energy Option

This feature automatically saves on x-ray irradiation volume when no product comes down the line for a specified period of time. This helps save costs by also extending the life of consumable parts.



Ease of Cleaning

This model is HACCP compliant. It is made of entirely stainless steel construction and the inspection chamber is of a waterproof construction.

Easy to Attach and Remove Parts

The protective curtain and conveyor can be easily removed without tools. The inspection chamber complies with waterproof specifications (IP66 compliant), so you can wash with water, ensuring good hygiene.



Protective Curtain



Belt



Conveyor Frame



Safety and Security

Failsafe design. Supports safe, secure production.

Only Ships Products that Passed Inspection

Products that did not pass the inspection will not be mixed in with shipped products, even if the connected sorting device malfunctions.

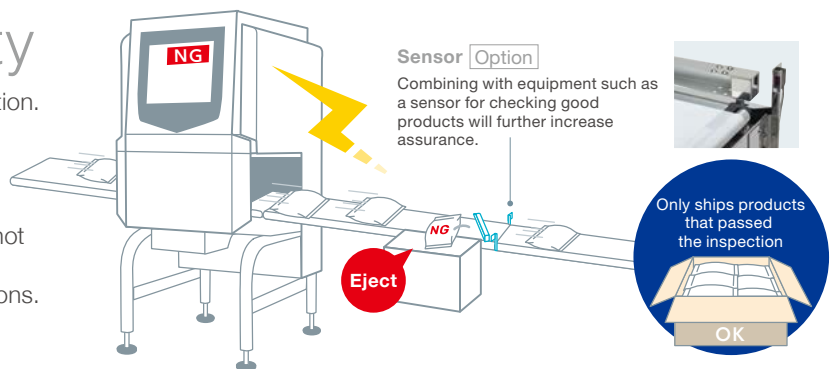

Comes in Various Models

Curtainless Type (for chicken and loose products)

This curtainless type is designed for unwrapped products like meat and loose products such as solid spices. With a trapezoidal conveyor, even a short protective cover will prevent x-ray leakage, shortening the machine.

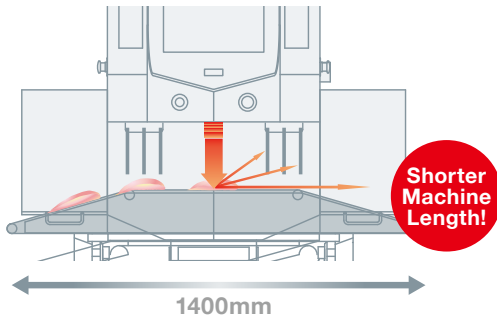

Multi-Line Inspection Type Option

One system can inspect up to four lines.

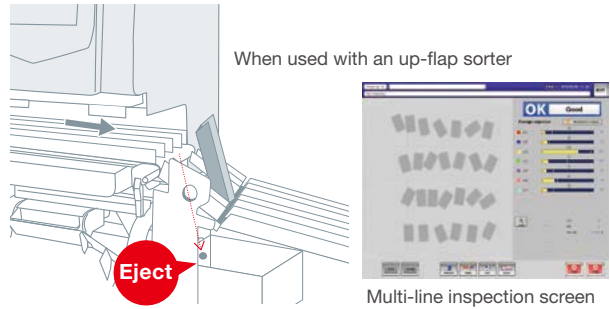

Fast Rank Selection

Widely used at production sites for oysters, scallops, bell peppers, etc. To match production volume, you can select the two-line inspection type, or the high-speed inspection type. Capable of a maximum of 16 selection ranks. Foreign object detection can be done simultaneously with rank selection, contributing to quality improvement.

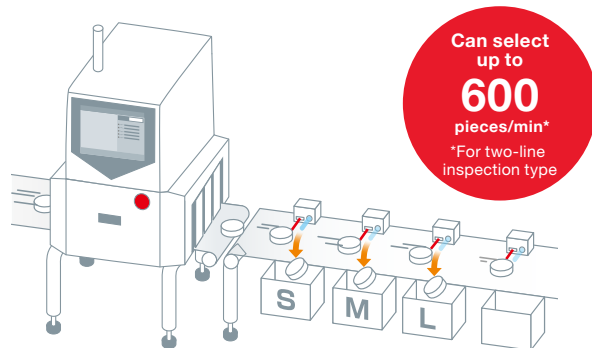

Checking for Weight of Continuous Packaged Products

Using the weight estimation feature, it is possible to inspect the weight of individual packets of continuous packaged products such as instant noodle soup and spices. Also, it can simultaneously inspect for foreign objects.

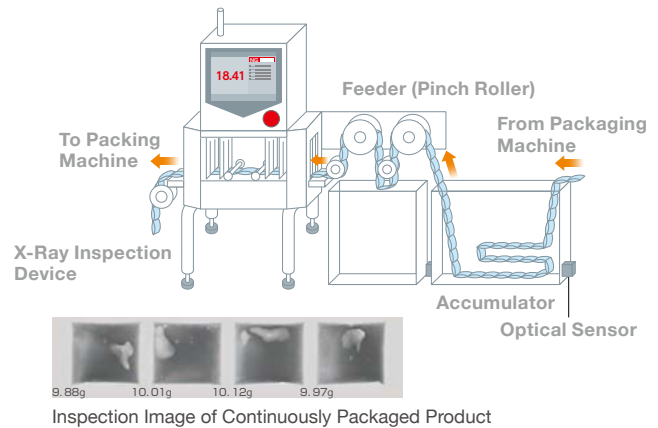

Rejector lineup

A variety of rejection systems are available to suit different products and production lines.

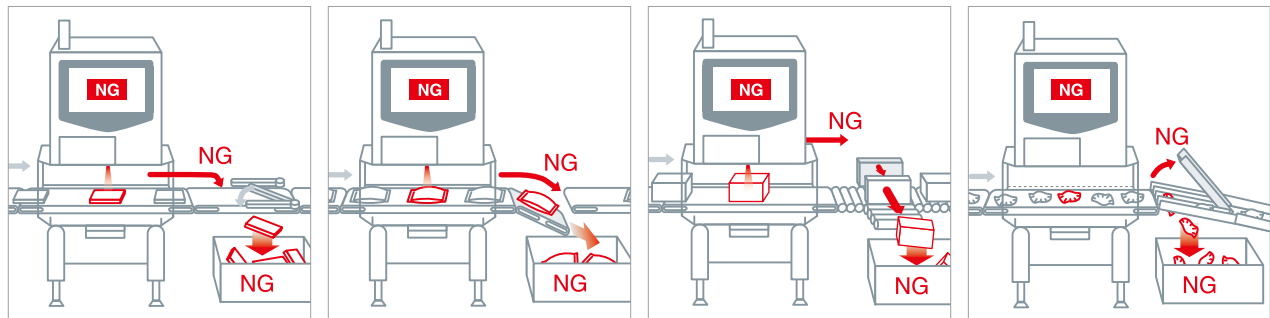

Arm rejector

Arm rejector is a general-purpose system, appropriate for thick products.

Drop belt rejector

Drop belt rejector sorts products with a vertically movable belt. It is suitable for rejecting thin products.

Push plate rejector

Push plate rejector sorts products on a conveyor using an air-driven device. It is suitable for rejecting heavy items such as cardboard and kraft paper products.

Up flap rejector

Up flap rejector has a vertically movable flap that allows product to drop below it. It is suitable for separating small bulk items.



ISHIDA CO., LTD. www.ishida.com

44 Shogoin Sannocho, Sakyo-ku,
Kyoto, 606-8392, Japan
Tel: +81 (0)75 751 1618 Fax: +81 (0)75 751 1634



HEAT AND CONTROL, INC.

www.heatandcontrol.com
21121 CABOT BLVD. HAYWARD, CA 94545-1132 USA
info@heatandcontrol.com